

SOLA LED D SLIM MVS 20W NW	1360 lm	2680 lm	
SOLA LED D SLIM MVS 28W NW	1900 lm	3570 lm	

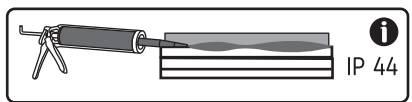

A  0,3-1 m/s

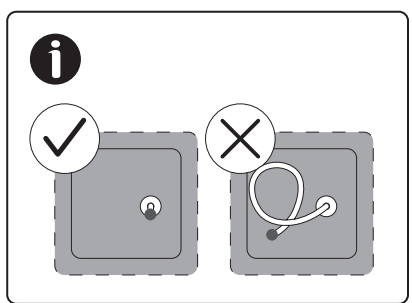

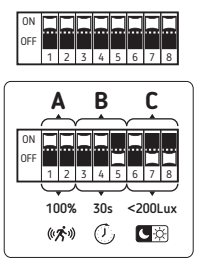
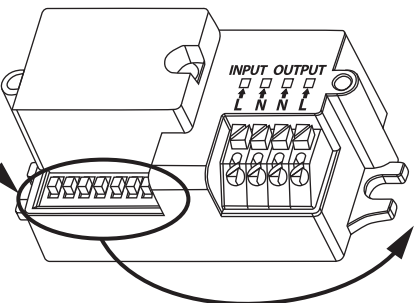
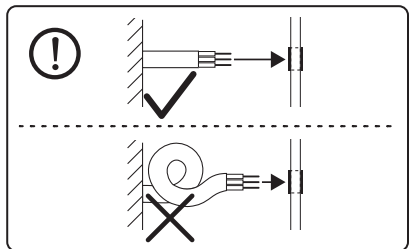
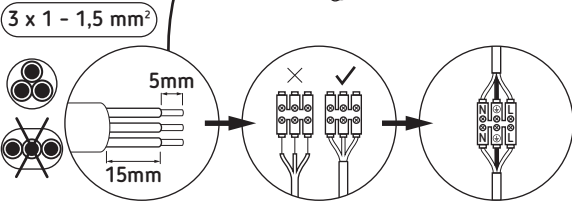
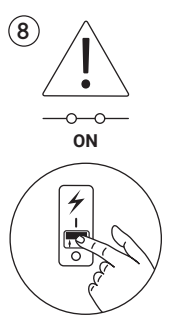
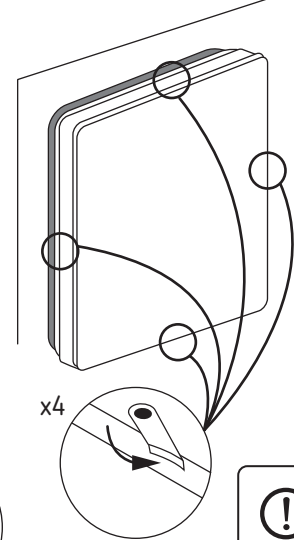
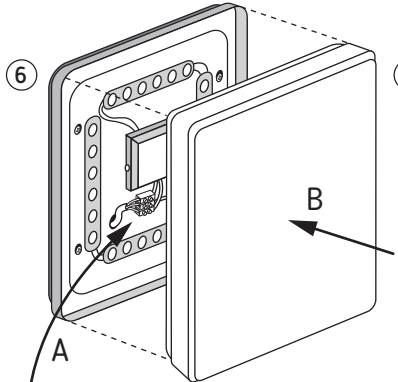
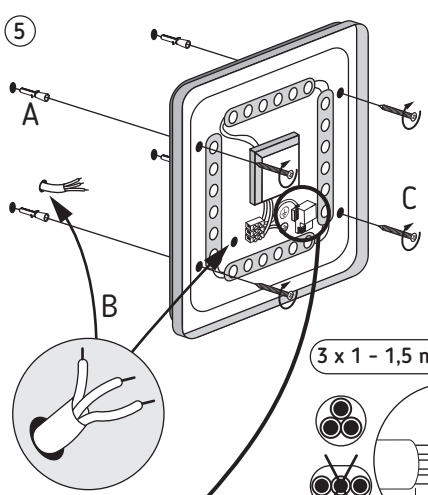
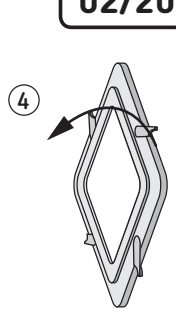
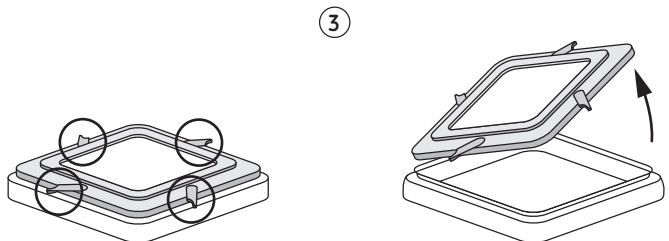
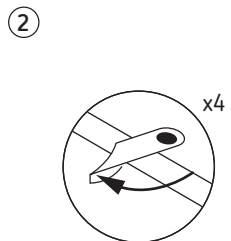
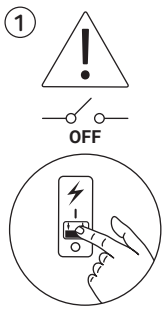
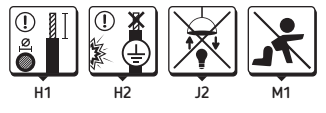
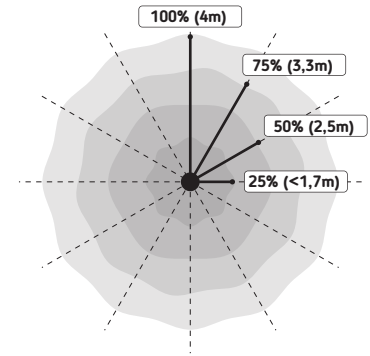
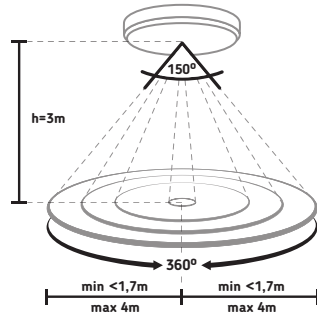
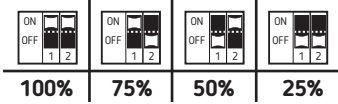

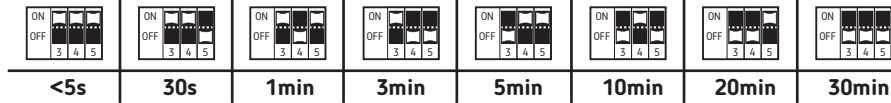



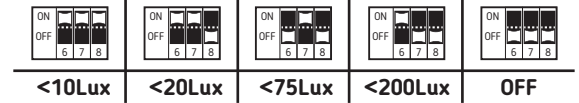

B 

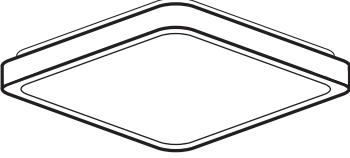

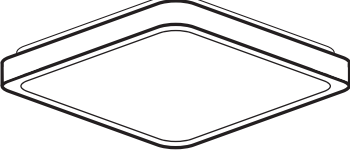
C 



   	  
---	--

		
	A5	B5

1