

LEON LED C MVS 12W NW	1120 lm	1280 lm	A14-F
LEON LED C MVS 16W NW	1360 lm	1650 lm	
SOLA LED C MVS 12W NW	1120 lm	1290 lm	
SOLA LED C MVS 16W NW	1390 lm	1690 lm	

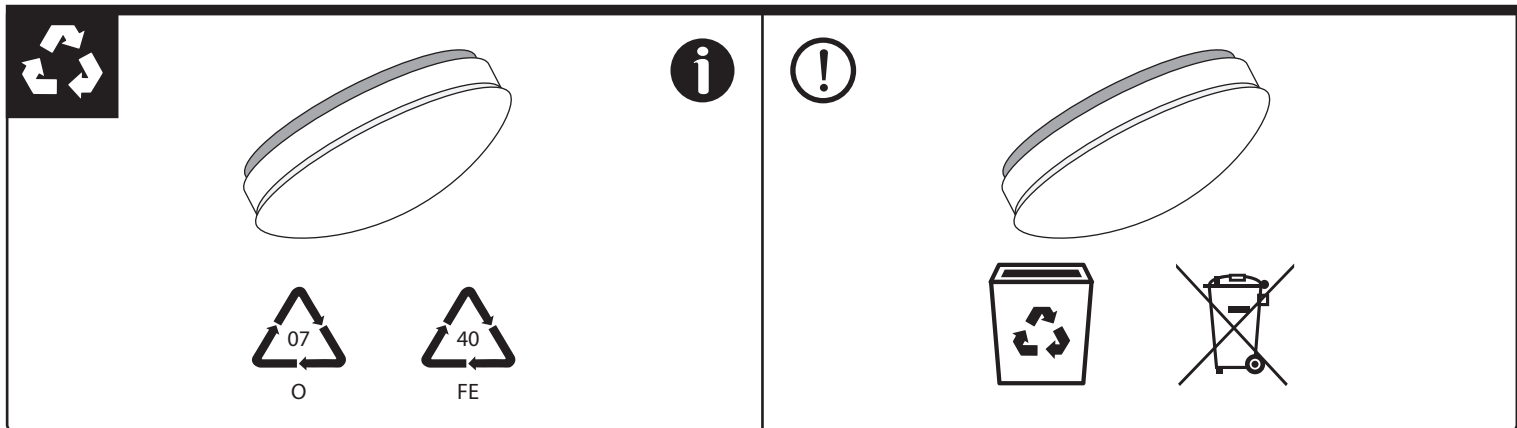

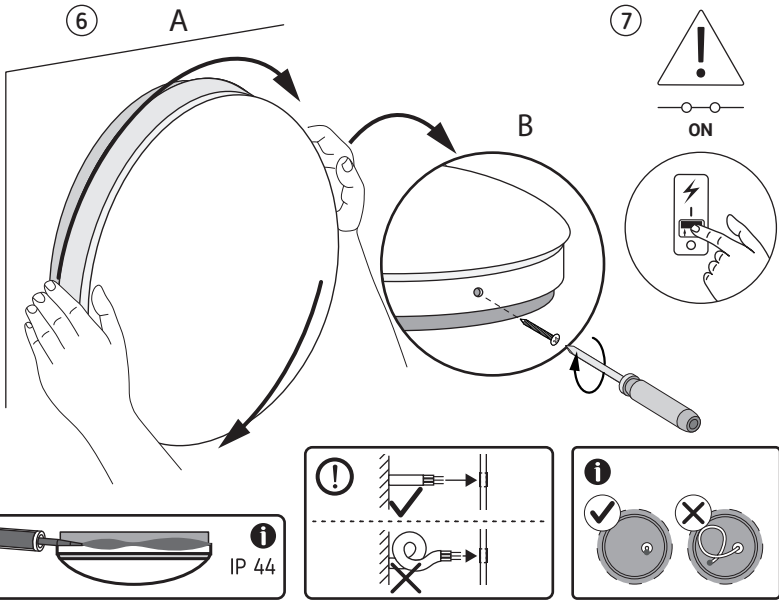
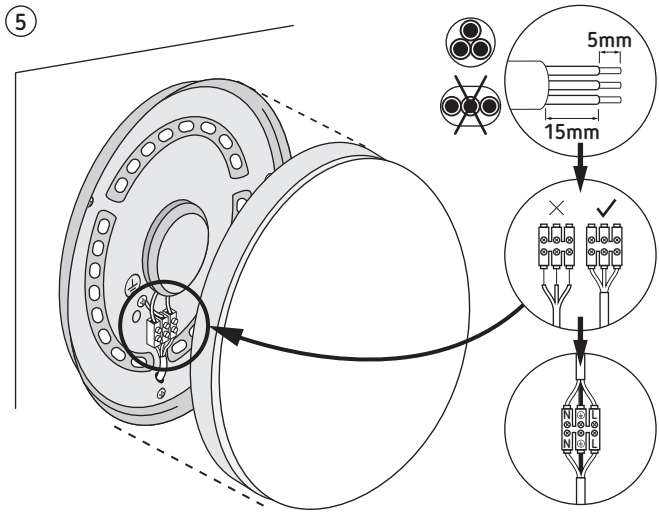
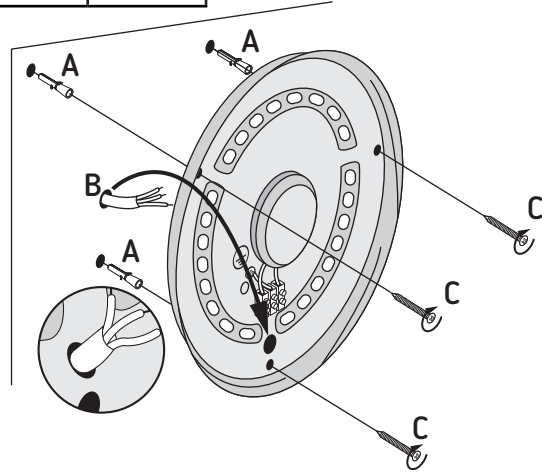
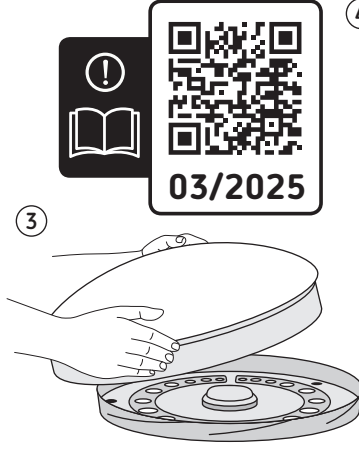
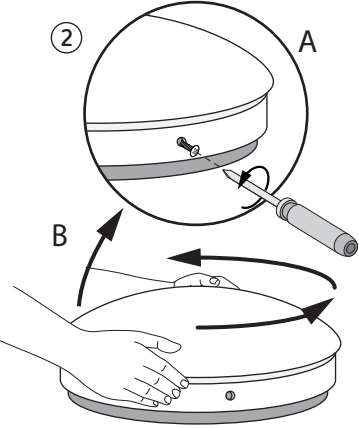
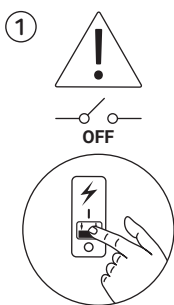

A5

B5

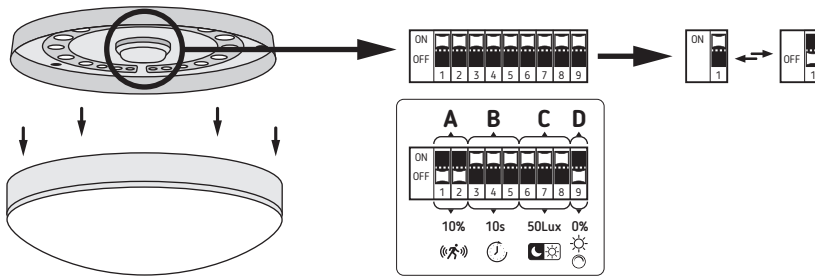

A 0,5-3 m/s

100% -38m ²	75% -29m ²	50% -19m ²	10% -4m ²

π	r2	S	Sens	r (m)	h (m)
3,14	38,44	120,70	100%	6,20	2,5
3,14	28,83	90,50	75%	4,80	2,5
3,14	19,22	60,40	50%	3,40	2,5
3,14	3,84	12,1	10%	1,80	2,5

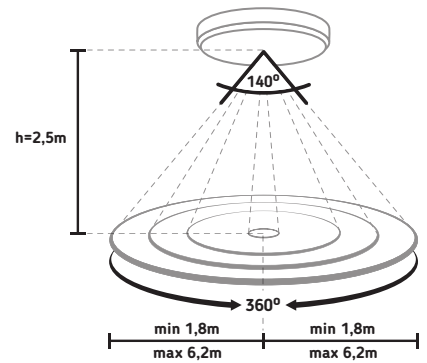
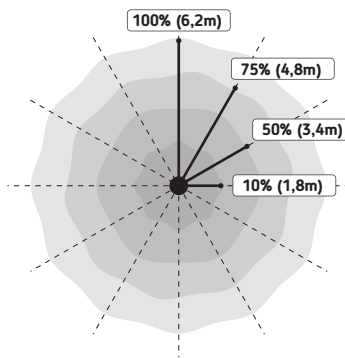

B

10s	1min	5min	10min	30min

C

<50Lux	<100Lux	<300Lux	<500Lux	OFF

D

30%	0%

