

12V

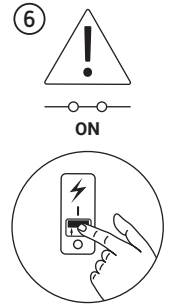

1 → 5 A, B → 4 → 3 C, A

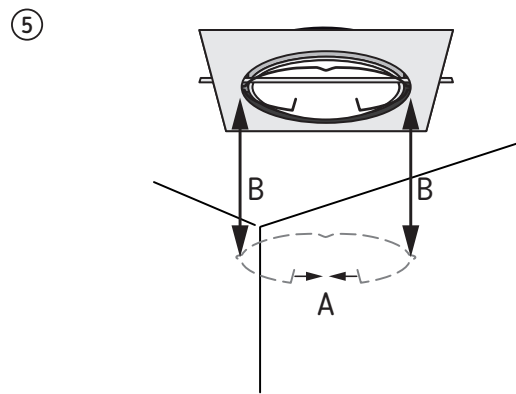
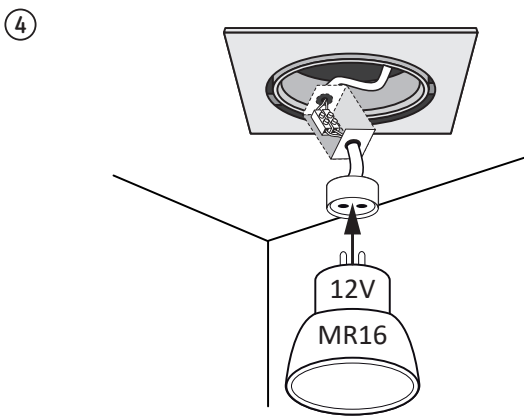
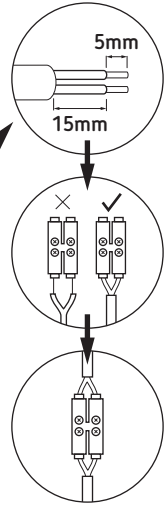
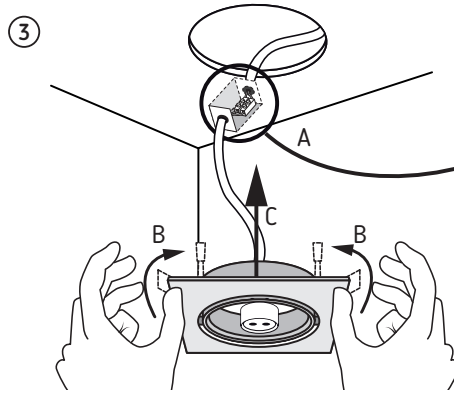
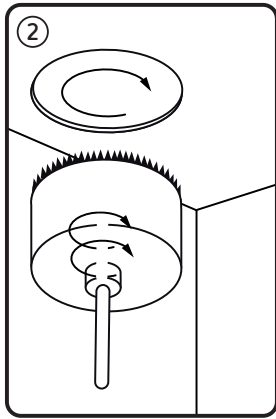
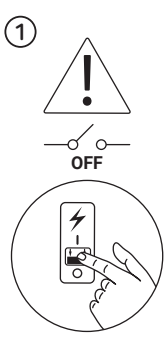